

EPUMENT[®] | Mineral casting for cutting-edge machine beds and components

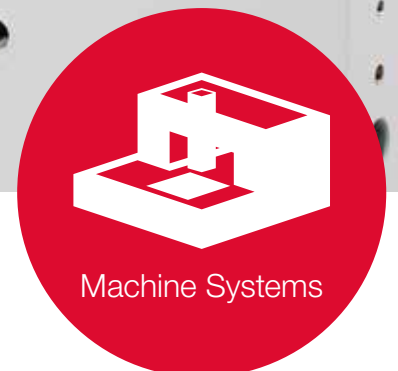

Innovative solutions for highly dynamic production technology

RAMPF Group

The international RAMPF Group stands for **engineering and chemical solutions** and caters to the economic and ecological needs of industry.

Our range of competencies includes:

- > Production and recycling of **materials** for modeling, lightweight construction, bonding, and protection
- > **Technical production systems** for precise, dynamic positioning and automation, as well as technologies for complex composite parts production
- > **Comprehensive range of solutions and services**, particularly for innovative customer-specific requirements

This know-how helps our customers achieve profitable and sustainable growth.

Trusting relationships are of utmost importance to RAMPF. They are a vital part of the success story of the family-owned company, which now spans over 35 years.

RAMPF thinks globally and acts locally. The company has production facilities strategically located in Germany, in the United States, Canada, China, and Japan.

RAMPF Machine Systems

Based in Wangen (near Göppingen), Germany, the company is the market-leading development partner and system supplier of complete machine bed solutions and machine systems.

Its service portfolio includes system solutions, trunk machines, basic machinery, and multi-axis positioning and moving systems based on machine beds and machine bed components made from alternative materials such as mineral casting, hard stone, ultra-high performance concrete, aluminum foam, and fiber composites.

High-precision machine systems are created using innovative replication, grinding, and lapping processes in temperature-controlled production environments.

This makes RAMPF Machine Systems the full-service partner for developing and manufacturing future-oriented machinery and production technology for a wide range of industries.



Machine Systems



Production Systems



Composite Solutions



Eco Solutions



Polymer Solutions



Tooling Solutions



Industries



Machine Tools

EPUMENT® mineral casting for productive and precise machine tools used in applications such as milling, turning, grinding, and eroding

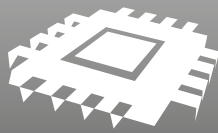

Production

EPUMENT® mineral casting for cutting-edge production equipment in electronics, photonics, display, solar, and battery applications

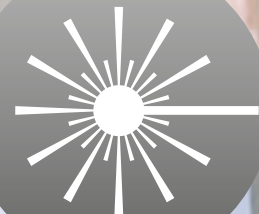



















Laser Technology

EPUMENT® mineral casting for innovative laser applications, including cutting, removing, coating, joining, scoring, testing, and marking

Your industry | Your application

We have been serving well-known customers across the globe for 40 years. In the European and Asian markets, we develop and produce innovative mineral casting beds at our own factories for all kinds of applications and industries involved in high-performance production technology.

-  Machine tools
-  Laser applications
-  Solar module production
-  Electronics production
-  Microproduction
-  Measuring, testing, and inspection technology
-  Packaging machinery
-  Display technology
-  Battery production
-  Woodworking machinery
-  Medical technology
-  Power machines
-  Optics production
-  Graphics machinery
-  Food technology
-  Pick & place applications
-  Textile machinery
-  Dispensing technology

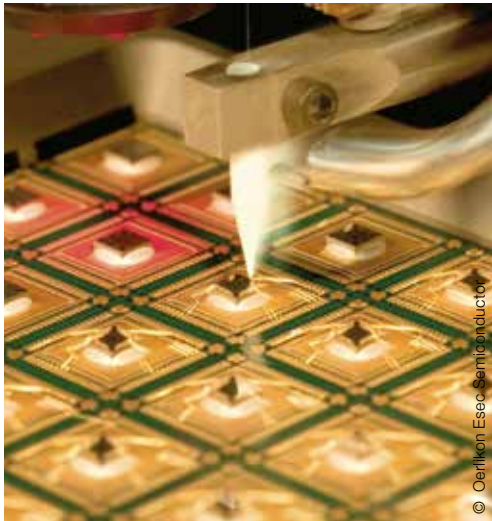

Properties



EPUMENT® | Mineral casting

A vibration-damping machine bed material for highly dynamic mechanical engineering applications and technologies

EPUMENT® mineral casting is a high-tech material that is perfect for the primary machine bed functions, such as precisely securing the geometric position of the individual machine elements, and the static, dynamic, thermal, and acoustic absorption of forces and moments.

It boasts high media resistance, e. g. to cutting oils and coolants, flawless ecological credentials thanks to resource-saving manufacture, and environmentally sound disposal and recycling options.



Your benefits

- > Superior damping to metal materials improves the dynamic stability of the machine bed structure in fast and accurate production machinery
- > Machine beds and machine bed components with an excellent mass/rigidity ratio
- > Fewer faults when subjected to thermal loads thanks to high thermal inertia

	Measure	EPUMENT® 145/B	EPUMENT® 140/8B	EPUMENT® 140/5
Density	g/cm ³	ca. 2.4	ca. 2.3	ca. 2.3
Modulus of elasticity (compression testing)*	kN/mm ²	40–45	35–40	30–35
Poisson's ratio		ca. 0.30	ca. 0.29	ca. 0.28
Compressive strength*	N/mm ²	130–150	130–150	140–160
Flexural strength	N/mm ²	30–35	30–35	35–45
Coefficient of thermal expansion (20°C)	10 ⁻⁶ K ⁻¹	ca. 15	ca. 16	ca. 19.5
Logarithmic decrement		0.022	0.03	0.035
Maximum particle size	mm	16	8	5
Minimum castable wall thickness	mm	80	50	40

* Measured on Form + Test Seidner testing machine, model 502/3000/100SP

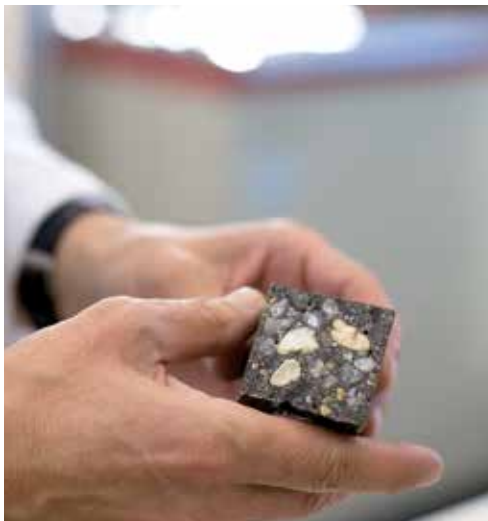

Design



EPUMENT® | Engineering, design, modeling

Services for material-specific design of mineral casting beds and bed components

RAMPF Machine Systems is the end-to-end development partner for system solutions made of EPUMENT® mineral casting — from material-specific design and engineering to FEM modeling and the design of casting molds, replication gauges, and fixtures.

Low casting temperatures combined with innovative precision and bonding technologies produce precise machine components with high functionality and an exceptional level of integration.



Your benefits

- > High level of integration reduces assembly throughput times; conduits/lines and sensors are an integral part of the mineral casting beds
- > Unconventional bed and variant structures for machines thanks to flexible modeling, non-cutting replication, and innovative bonding technology
- > EPUMENT® mineral casting's surface and design functionality cuts machine cover/cladding costs

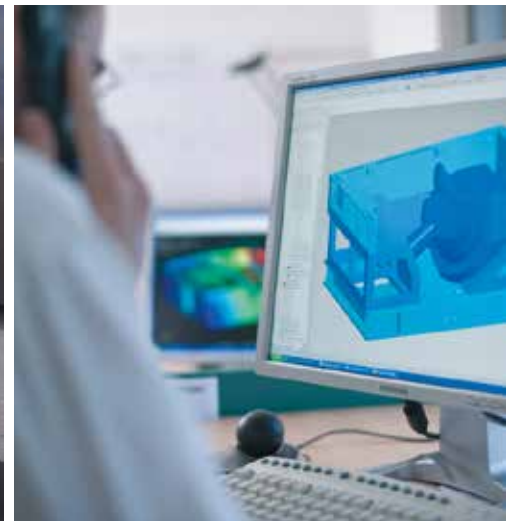

Manufacture



EPUMENT® | Production, accuracy, precision assembly

Complete service offering with ready-to-use mineral casting bed as a system solution

RAMPF Machine Systems is the system supplier of complete mineral casting beds with high-performance production technology. State-of-the-art foundry equipment, climate-controlled replication halls, and an in-house precision grinding center underline the outstanding position of the world market leader.

Based on the latest technologies and a reliable quality assurance system to ISO 9001 : 2008, the company supplies complex mineral casting structures and assemblies with excellent dimensional accuracy, top quality, and the best possible price/performance ratio.



Your benefits

- > Shorter assembly times in production thanks to optimum accuracies and a high level of finishing; guides and other machine elements are already fitted with high precision
- > High availability and short delivery times thanks to three self-sufficient production plants located across the globe
- > Low tooling costs due to the impressive service lives of molds and gauges



Applications



EPUMENT® | Industrial applications and references

for machine beds and machine bed components made from mineral casting

Machines have a bed base, regardless of whether they form, remove, join, apply, assemble, test, or install materials.

Today's production equipment needs to satisfy growing demands in terms of process accuracies under static, dynamic, and thermal loads. Machine beds and machine bed components made from EPUMENT® mineral casting play a key role in meeting these high expectations thanks to their minimum deformation under maximum loads.

Every working day, up to 20 mineral casting machine beds with unit weights of between 200 kilograms and 20 metric tons leave our facilities.



Additional information

- > **Image on opposite page:** Machine bed of a high-speed milling machine (11,920 kg; precision-ground surfaces, fitted guides, high-precision bonding of bed and gantry)
- > **Image bottom left:** Bed of a tool grinding machine (3,520 kg; non-cutting replication of precision surfaces, fitted guides, high-precision bonding of bed with chip tray and stand)
- > **Image bottom right:** Inclined lathe bed (8,630 kg; precision-ground surfaces, complex conduit system integrated)



Applications

1



4



2



5



3



6



7

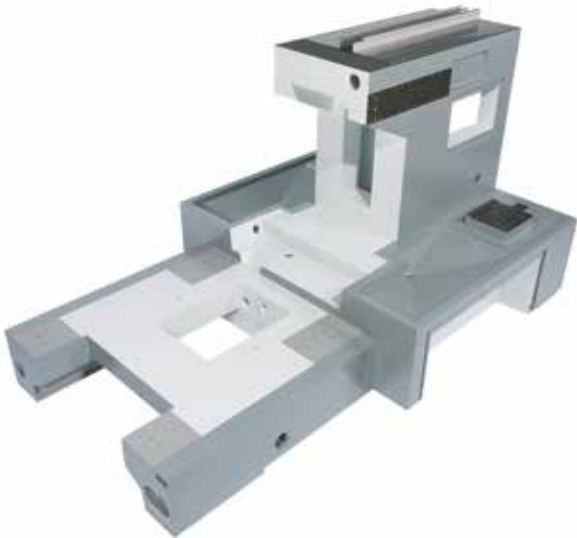

8



9



Additional information

Image 1: Bed of a die bonder (800 kg; cast in one piece; non-cutting replication of precision surfaces in three planes)

Image 2: Bed of a jet printer for electronics production (1,680 kg; non-cutting replication of precision surfaces, fitted guides, cladding and design functions integrated in mineral casting)

Image 3: Mineral casting base of a flip-chip bonder (330 kg; precision-ground surfaces)

Image 4: Base of a tool presetting unit (840 kg; non-cutting replication of precision surfaces, cladding and design functions integrated in mineral casting)

Image 5: Bed of a laser machining unit (840 kg; cast in one piece; non-cutting replication of precision surfaces, cladding and design functions)

Image 6: Cabin of an X-ray-based measuring device made from radiation-absorbing EPURAM mineral casting (4,800 kg, mineral casting assumes load-bearing, vibration-damping, radiation-absorbing, and design functions)

Image 7: Bed of a diamond-wire wafer saw (3,870 kg; cast in one piece; non-cutting replication of precision surfaces)

Image 8: Bed of a high-speed milling machine (3,760 kg; precision-replicated surfaces, guides fitted, high-precision bonding of bed and gantry)

Image 9: Bed of a 5-axis universal machining center (4,180 kg; precision-replicated surfaces in two planes, bed and upper section screwed together; non-cutting replication of contact surfaces; integrally cast cooling system for X-axis)

RAMPF Group | Locations

